

M-BUS to Modbus TCP Server Gateway

USER MANUAL
Version 1.0.2
Publication date 2024-06-05



Copyright © 2023 Intesis

Disclaimer

The information in this document is for informational purposes only. Please inform HMS Networks of any inaccuracies or omissions found in this document. HMS Networks disclaims any responsibility or liability for any errors that may appear in this document.

HMS Networks reserves the right to modify its products in line with its policy of continuous product development. The information in this document shall therefore not be construed as a commitment on the part of HMS Networks and is subject to change without notice. HMS Networks makes no commitment to update or keep current the information in this document.

The data, examples and illustrations found in this document are included for illustrative purposes and are only intended to help improve understanding of the functionality and handling of the product. In view of the wide range of possible applications of the product, and because of the many variables and requirements associated with any particular implementation, HMS Networks cannot assume responsibility or liability for actual use based on the data, examples or illustrations included in this document nor for any damages incurred during installation of the product. Those responsible for the use of the product must acquire sufficient knowledge in order to ensure that the product is used correctly in their specific application and that the application meets all performance and safety requirements including any applicable laws, regulations, codes and standards. Further, HMS Networks will under no circumstances assume liability or responsibility for any problems that may arise as a result from the use of undocumented features or functional side effects found outside the documented scope of the product. The effects caused by any direct or indirect use of such aspects of the product are undefined and may include e.g. compatibility issues and stability issues.

Table of Contents

1. Description and Order Codes	1
2. Gateway Capacity	2
3. General Information	3
3.1. Intended Use of the User Manual	3
3.2. General Safety Information	3
3.3. Admonition Messages and Symbols	3
4. Overview	5
4.1. Inside the Package	5
4.2. Gateway Main Features	5
4.3. Gateway General Functionality	6
5. Hardware	7
5.1. Mounting	7
5.2. Connection	9
5.2.1. Gateway Connectors	9
5.2.2. Common Connections	10
5.2.2.1. Connecting the Gateway to the Power Supply	10
5.2.3. Connection Procedure for M-Bus	10
5.2.4. Connection Procedure for Modbus TCP	11
5.3. Technical Specifications	11
5.4. Dimensions	12
6. M-Bus System	13
6.1. General Description	13
6.2. M-Bus Interface	13
6.3. M-Bus Signals	13
7. Modbus System	14
7.1. General Description	14
7.2. ModBus Interface	14
7.3. Functions Supported	14
7.4. Modbus TCP	14
7.5. Address Map	15
7.6. Modbus Server Interface Points Definition	15
8. Setup Process with the Configuration Tool	16
8.1. Prerequisites	16
8.2. Intesis MAPS Configuration and Monitoring Tool	16
8.2.1. Introduction	16
8.2.2. Create a New Project from a Template	17
8.2.3. Main Menu Overview	18
8.2.4. Connection Tab	18
8.2.5. Configuration Tab	19
8.2.6. Signals Tab	19
8.2.7. Receive/Send Tab	20
8.2.8. Diagnostic Tab	21

1. Description and Order Codes

INBSMEBxxx0100 Protocol Translator Gateway

M-Bus to Modbus TCP server gateway

ORDER CODE	LEGACY ORDER CODE
INBSMEB0200100	IBBSMEB0200100
INBSMEB0500100	IBBSMEB0500100



NOTICE

The order code may vary depending on the product seller and the buyer's location.

2. Gateway Capacity

Element	INMBSMEB0200100	INMBSMEB0500100	Notes
Type of Modbus client devices	Modbus TCP		Those supporting the Modbus protocol. Communication over TCP/IP.
Number of Modbus client devices	Up to five TCP connections		Number of Modbus client devices supported by the gateway.
Number of Modbus registers	500	1250	Maximum number of points that can be defined in the virtual Modbus server device inside the gateway.
Type of M-Bus devices	M-Bus EIA-485 slave devices		Those supporting the M-Bus EN-1434-3 Standard. Communication over EIA-485.
Number of M-Bus slave devices	20	50	Number of M-Bus slave devices supported by the gateway.
Number of M-Bus signals	500	1250	Number of M-Bus signals (readings in the meters) that can be read from the gateway.

3. General Information

3.1. Intended Use of the User Manual

This manual contains the main features of this Intesis gateway and the instructions for its appropriate installation, configuration, and operation.

The contents of this manual should be brought to the attention of any person who installs, configures, or operates this gateway or any associated equipment.

Keep this manual for future reference during the installation, configuration, and operation.

3.2. General Safety Information



IMPORTANT

Follow these instructions carefully. Improper work may seriously harm your health and damage the gateway and/or any other equipment connected to it.

Only technical personnel, following these instructions and the country legislation for installing electrical equipment, can install and manipulate this gateway.

Install this gateway indoors, in a restricted access location, avoiding exposure to direct solar radiation, water, high relative humidity, or dust.

Preferably, mount this gateway on a DIN rail inside a grounded metallic cabinet, following the instructions in this manual.

If mounting on a wall, firmly fix this gateway on a non-vibrating surface, following the instructions in this manual.

All wires (for communication and power supply, if needed) must only be connected to networks with indoor wiring. All communication ports are considered for indoor use and must only be connected to SELV circuits.

Disconnect all systems from power before manipulating and connecting them to the gateway.

Use SELV-rated NEC class 2 or limited power source (LPS) power supply.

Supply the correct voltage to power the gateway. The admitted range is detailed in the technical specifications table.

Respect the expected polarity of power and communication cables when connecting them to the gateway.

This Intesis gateway is designed for installation in an enclosure. When the device is mounted outside an enclosure, precautions should be taken to avoid electrostatic discharges to the unit in environments with static levels above 4 kV. When working in an enclosure (e.g., making adjustments, setting switches, etc.), typical anti-static precautions should be observed before touching the unit.

Binary inputs, if present, are potential-free contact. Do not connect any voltage.

3.3. Admonition Messages and Symbols



DANGER

Instructions that must be followed to avoid an imminently hazardous situation that, if not avoided, will result in death or severe injury.

**WARNING**

Instructions that must be followed to avoid a potentially hazardous situation that, if not avoided, could result in death or severe injury.

**CAUTION**

Instruction that must be followed to avoid a potentially hazardous situation that, if not avoided, could result in minor or moderate injury.

**IMPORTANT**

Instruction that must be followed to avoid a risk of reduced functionality and/or damage to the equipment or to avoid a network security risk.

**NOTE**

Additional information which may facilitate installation and/or operation.

**TIP**

Helpful advice and suggestions.

**NOTICE**

Remarkable Information.

4. Overview

This Intesis® gateway allows to integrate M-Bus devices into Modbus TCP systems easily.

The aim of this integration is to make M-Bus devices accessible from a Modbus control system or device to get the same behavior as if the M-Bus device was part of the Modbus installation.

For this, the Intesis gateway acts as a Modbus TCP server device in its Modbus interface, allowing it to read/write points from the Modbus client device(s). From the M-Bus point of view, the gateway acts as an M-Bus level converter and Master device (EN-1434-3). The gateway performs the readings of the M-Bus slave device(s) by automatic continuous polling, or on demand (to reduce battery consumption).

The gateway configuration is carried out through the Intesis MAPS configuration tool.

Figure 1. Integration of M-Bus devices into Modbus TCP installations

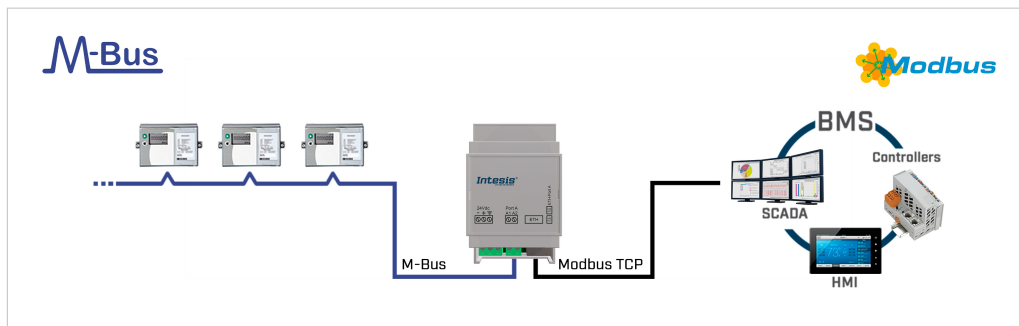

IMPORTANT

This document assumes that the user is familiar with Modbus and M-Bus technologies and their technical terms.

4.1. Inside the Package

Items included:

- Intesis INMBSMEBxxx0100 Protocol Translator Gateway
- Installation guide

4.2. Gateway Main Features

- Embedded level converter. Direct connection to M-Bus devices with no extra hardware required.
- Scan function: detect M-Bus devices and their available registers automatically.
- Import/Export of M-Bus device templates.
- Baud rate configurable within the M-Bus allowed range (300 to 9600 bps. The devices are normally configured at 2400 bps).
- Specific parameters and timeouts are available to maximize compatibility with any possible peculiarity between different meter manufacturers.
- Availability of variables for communication errors, both at meter and general level, helping you to know if the communication with one or more meters has failed.
- Flexible configuration using the Intesis MAPS configuration tool.

4.3. Gateway General Functionality

This gateway acts as a server on its Modbus side and as a master on its M-Bus interface, thus allowing the integration of M-Bus devices into a Modbus system.

The gateway is continuously polling the devices (together or individually), storing in its memory the current status of every signal you want to track, and serving this data to the installation when requested. This continuous polling can be activated/deactivated through a Modbus signal. It is also possible to configure the gateway to make a single polling of the meters (refresh of readings) at startup.

Primary or secondary addressing is allowed for M-Bus devices. When a signal status changes, the gateway sends a write telegram to the installation, waits for the response, and performs the corresponding action.

This action can be: force a polling of a specific M-Bus device or force a polling of all M-Bus devices. This can also be forced from the Modbus side at any time by writing a 1 in the corresponding binary point specially enabled for this purpose.

Other M-Bus information accessible from Modbus, using specific points of the gateway, is:

- Bus activity: Indicates if meters are currently being polled or polling is on standby.
- M-Bus status of every meter: This is sent by the own meter with every poll and indicates the internal status, which is manufacturer specific in every case.

A lack of response from a signal activates a communication error, allowing you to know which signal from which M-Bus device is not correctly working. There is also a general communication error available that will be active whenever the communication with one or more M-Bus meters has failed.

5. Hardware

5.1. Mounting

**IMPORTANT**

Before mounting, please ensure that the chosen installation place preserves the gateway from direct solar radiation, water, high relative humidity, or dust.

**NOTE**

Mount the gateway on a wall or over a DIN rail. DIN rail mounting inside a grounded metallic cabinet is recommended.

**IMPORTANT**

Ensure the gateway has sufficient clearances for all connections when mounted. See [Dimensions \(page 12\)](#).

Wall mounting

1. Press the rear panel clips outwards until you hear a *click*.
2. Use the clip holes to screw the gateway to the wall.
3. Make sure the gateway is firmly fixed.

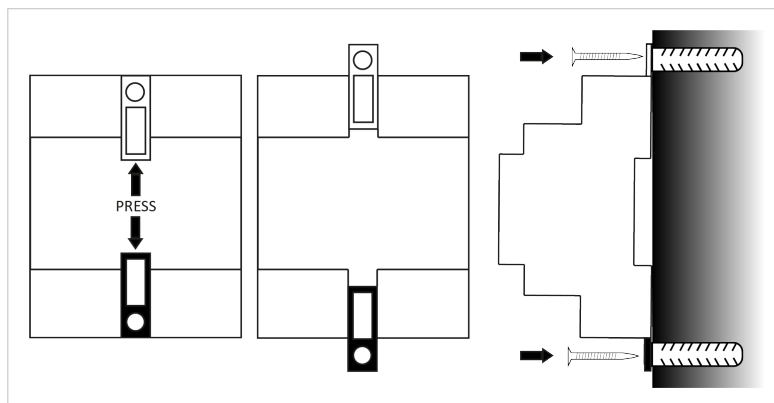

DIN rail mounting

Keep the rear panel clip in its original position.

1. Fit the gateway's top-side clip in the upper edge of the DIN rail.
2. Press the low side of the gateway gently to lock it in the DIN rail.
3. Make sure the gateway is firmly fixed.



NOTE

For some DIN rails, to complete step 2, you may need a small screwdriver or similar to pull the bottom clip down.

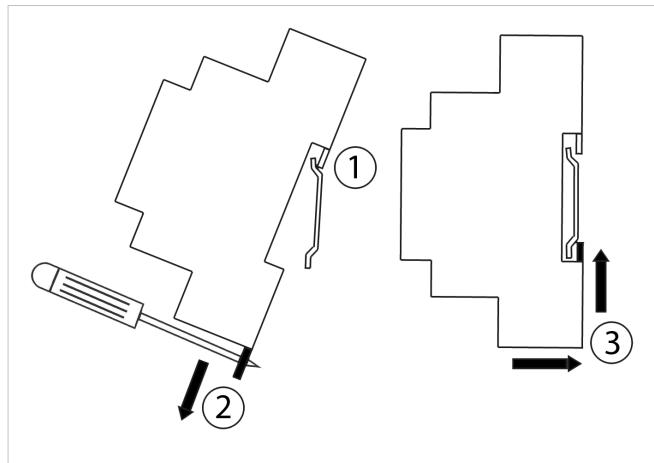

5.2. Connection



CAUTION

Disconnect all systems from power before manipulating and connecting them to the gateway.



IMPORTANT

Keep communication cables away from power and ground wires.

5.2.1. Gateway Connectors

Figure 2. General view of all gateway connectors

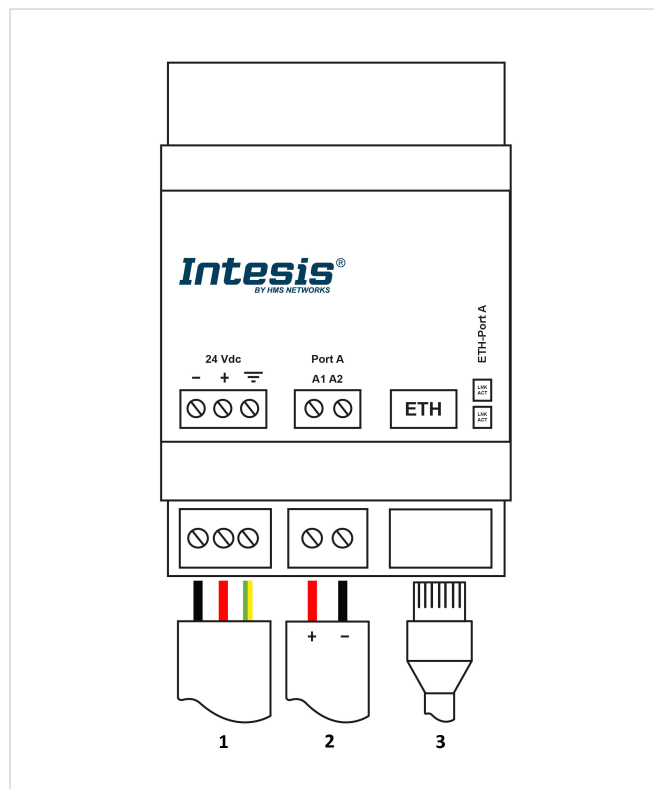

1. Power supply: 24 VDC, Max.: 220 mA, 5.2 W

2.Port A: M-Bus port, for M-Bus bus connection.

3. Ethernet port: For Modbus TCP connection.

Port A connectors	M-Bus wires
A1	+
A2	-



NOTE

You can also use the **Ethernet Port** to connect the gateway to the PC for configuration purposes.



NOTE

Mount the gateway in the desired installation site before wiring.

**IMPORTANT**

Use solid or stranded wires (twisted or with ferrule).

Wire cross-section/gauge for all wire connectors:

- One core: 0.2 to 2.5 mm² (24 to 11 AWG).
- Two cores: 0.2 to 1.5mm² (24 to 15 AWG).
- Three cores: Not permitted.

**NOTE**

To know more about each port's specifications, see [Technical Specifications \(page 11\)](#).

5.2.2. Common Connections

5.2.2.1. Connecting the Gateway to the Power Supply

The power supply connector is a green pluggable terminal block (3 poles) labeled as **24Vdc**.

**IMPORTANT**

- Use a SELV-rated NEC class 2 or limited power source (LPS) power supply.
- Connect the gateway's ground terminal to the installation grounding.
- A wrong connection may cause earth loops that can damage the Intesis gateway and/or any other system equipment.

Apply the voltage within the admitted range and of enough power:

- 24 VDC, Max.: 220 mA, 5.2 W

**IMPORTANT**

- Respect the polarity labeled on the power connector for the positive and negative wires.

5.2.3. Connection Procedure for M-Bus

The gateway connects directly to the M-Bus system without requiring any external RS-232 or EIA-485 to M-Bus level converter.

Connect the M-Bus bus to connectors A1 (+) and A2 (-) of the gateway's Port A. Respect the polarity.

Remember that the gateway provides 36 VDC M-Bus voltage to the bus, acting also as an M-Bus level converter.

In case no response from the M-Bus device(s) to the frames sent by the gateway is received, check that they are operative and reachable from the network connection used by the gateway.

5.2.4. Connection Procedure for Modbus TCP



NOTE

Remember to check the [Common Connections \(page 10\)](#).

- Connect the Modbus TCP Ethernet cable to the gateway's **Ethernet Port**.



IMPORTANT

Use a straight Ethernet UTP/FTP CAT5 or higher cable.



IMPORTANT

When commissioning the gateway for the first time, DHCP will be enabled for 30 seconds. After that time, the default IP address 192.168.100.246 will be set.



NOTE

The default port is 502.



IMPORTANT

If communicating through the LAN of the building, contact the network administrator and make sure traffic on the used port is allowed through all LAN paths.

5.3. Technical Specifications

Housing	Plastic, type PC (UL 94 V-0). Color: Light Grey. RAL 7035 Net dimensions (HxWxD): 93 x 53 x 58 mm / 3.6 x 2.1 x 2.3"
Mounting	Wall DIN rail (recommended mounting) EN60715 TH35
Terminal wiring For power supply and low-voltage signals	Per terminal: solid wires or stranded wires (twisted or with ferrule) Wire cross-section/gauge: One core: 0.2 mm ² .. 2.5 mm ² (24 .. 11 AWG) Two cores: 0.2 mm ² .. 1.5 mm ² (24 .. 15 AWG) Three cores: Not permitted For distances longer than 3.05 meters (10 feet), use Class 2 cables.
Power	1 x Green pluggable terminal block (3 poles) 24 VDC, Max.: 220 mA, 5.2 W Recommended: 24 VDC, 220 mA
Ethernet	1 x Ethernet 10/100 Mbps RJ45
Port A	1 x M-Bus port: pluggable terminal block (two poles) M-Bus power consumption: • Normal operating level: 90 mA (50 M-Bus unit loads + 20%) • Collision detection: 25 mA • Overload level: 215 mA Voltage rating: 36 VDC
Operational temperature	Celsius: 0 .. 60°C / Fahrenheit: 32 .. 140°F
Operational humidity	5 to 95%, no condensation
Protection	IP20 (IEC60529)
LED indicators	2 x Onboard LED indicators Ethernet Link/Speed

5.4. Dimensions

- **Net dimensions (HxWxD)**

Millimeters: 93 x 53 x 58 mm

Inches: 3.6 x 2.1 x 2.3"

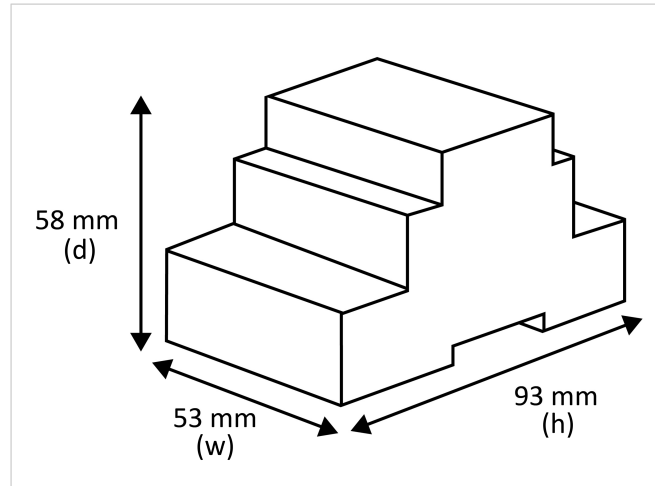

IMPORTANT

Ensure the gateway has sufficient clearance for all connections when mounted.

6. M-Bus System

6.1. General Description

The M-Bus ("Meter-Bus") is a European standard for remote reading of heat meters, and it is also usable for all other types of consumption meters, as well as for various sensors and actuators.

M-Bus standards are:

- EN 13757-2 (physical and link layer)
- EN 13757-3 (application layer)

Many manufacturers of energy meters, pulse counters, water meters, electricity meters, etc., add an M-Bus interface to their devices, enabling them to be interconnected and remotely monitored through a 2-wire bus based on the M-Bus standards. There are many manufacturers of these measurement devices incorporating the M-Bus interface, and also some other manufacturers of specific M-Bus communication devices such as bus repeaters, EIA-232/EIA-485 to M-Bus level converters, etc.

6.2. M-Bus Interface

The gateway connects directly to the M-Bus system. No external level converter is required.

Connection to the M-Bus is made via the EIA-485 connection. Notice that the gateway also powers the bus, so no extra hardware is required to connect to M-Bus compatible meters or devices.

6.3. M-Bus Signals

The gateway supports several meter magnitudes and units typically used on the energy, electric, water, and other meters. During the scan, the gateway imports each signal with the units and details provided by the meter. See the details of the units on the [Signals tab \(page 19\)](#) in Intesis MAPS.

The type of signals available from every meter may differ, depending on the manufacturer and model. Please refer to the device's technical documentation to determine the signals available for a given meter to integrate the desired ones.

Besides this, to simplify and speed up the identification of the signals offered by any device (and their type), a scanning function has been embedded in the firmware of the gateway to poll the meter and show details about the signals offered by the device and the corresponding signal code needed in the signals list of the gateway for every one of the signals to integrate, using the Intesis MAPS configuration tool.

7. Modbus System

7.1. General Description

The Modbus protocol is an application-layer messaging protocol developed by Modicon in 1979. It is used to establish client-server communication between intelligent devices over different types of buses or networks. The Intesis gateway supports Modbus TCP.

Modbus is a request/reply protocol and offers services specified by function codes. Modbus function codes are elements of Modbus request/reply PDUs (Protocol Data Units).

7.2. ModBus Interface

The Intesis gateway acts as a server device in its Modbus interface; the interface for this model is the Ethernet port. To access the points and resources of the gateway from a Modbus client device, you must specify the Modbus register addresses configured inside the gateway as those configured inside the gateway corresponding to the signals of the field device protocol.

7.3. Functions Supported

Table 1. Modbus functions

#	Function	Read/Write
01	Read Coils	R
02	Read Discrete Inputs	R
03	Read Holding Registers	R
04	Read Input Registers	R
05	Write Single Coil	W
06	Write Single Register	W
15	Write Multiple Coils	W
16	Write Multiple Registers	W

If poll records are used to read or write more than one register, the range of addresses requested must contain valid addresses; if not, the Intesis gateway will return the corresponding Modbus error code.

All registers are of 2 bytes¹, even if they are associated with signals of bit type on the other protocol's side. Its content is expressed in MSB .. LSB.²

Modbus error codes are fully supported. They are sent whenever a non-valid Modbus action or address is required.

7.4. Modbus TCP

Modbus TCP communication is characterized basically by the embedding of the Modbus RTU protocol into TCP/IP frames, which allows faster communication and a longer distance between client and server devices in comparison with RTU communication over a serial line. Another benefit is using common TCP/IP infrastructure in buildings and transmitting over WAN or the internet. It also allows the coexistence of one or more clients and, of course, one or more server devices in a given network, all interconnected through a TCP/IP-based network.

Use the configuration tool to configure the IP settings of the gateway (DHCP status, own IP, netmask, and default gateway) and the TCP port.

¹Default value, it can be configured to be 4 bytes if required.

²MSB: most significant bit; LSB: less significant bit

7.5. Address Map

The Modbus address map is fully configurable; any point in the gateway can be freely configured with the desired Modbus register address.

7.6. Modbus Server Interface Points Definition

The Modbus registers are fully configurable through the Intesis MAPS configuration tool; any point in the gateway can be freely configured with the desired Modbus register address.

Every point defined in the gateway has the following Modbus features associated with it:

Feature	Description
#Bits	<ul style="list-style-type: none"> • 1-bit • 16-bit • 32-bit
Data Coding Format	<ul style="list-style-type: none"> • 16/32 unsigned • 16/32-bit signed (one's complement – C1) • 16/32-bit signed (two's complement – C2) • 16/32-bit Float • 16/32-bit Bitfields • Error comm.
Function Code	<ul style="list-style-type: none"> • 1 - Read coils. • 2 - Read discrete inputs. • 3 - Read holding registers. • 4 - Read input registers. • 5 - Write a single coil. • 6 - Write a single register. • 15 - Write multiple coils. • 16 - Write multiple registers.
Byte Order	<ul style="list-style-type: none"> • Big Endian • Little Endian • Word Inverted Big Endian • Word Inverted Little Endian
Register Address	The Modbus register address inside the server device for the point.
Bit inside the register	<p>Bit inside the Modbus register (optional). The Intesis gateway allows bit decoding from generic 16 bits input/holding Modbus registers.</p> <p><i>Some devices use the bit coding into 16 bits input/holding Modbus registers to encode digital values. These registers are generally accessible using Modbus function codes 03 and 04 (read holding/input registers).</i></p>
Read/Write	<p>0: Read</p> <p>1: Trigger</p> <p>2: Read/Write</p>

8. Setup Process with the Configuration Tool

8.1. Prerequisites

For this integration, you need:

- The items delivered by HMS Networks:
 - The Intesis INMBSMEBxxx0100 Protocol Translator Gateway.
 - [Link to download the configuration tool](#).
 - Product documentation.
- The respective M-Bus devices connected to the Port A of the gateway.
- A computer to run the Intesis MAPS configuration tool.
Requirements:
 - Windows® 7 or higher.
 - Hard disk free space: 1 GB.
 - RAM: 4GB.
- An Ethernet cable.

8.2. Intesis MAPS Configuration and Monitoring Tool

8.2.1. Introduction

Intesis MAPS is a software tool for the configuration and monitoring of the Intesis gateways. It has been designed and developed in-house, ensuring an up-to-date tool to get all the potential of our gateways. It is compatible with Windows® 7 and higher.

The installation procedure and the main functions are explained in the [Intesis MAPS user manual](#). Please also check the Intesis MAPS user manual for specific information about the different parameters and how to configure them.

8.2.2. Create a New Project from a Template

1. Open Intesis MAPS.
2. Click **Create New Project** in the **Getting started** menu on the left.
You can create a project from scratch using a template. To find the appropriate template, filter the search by:
 - Clicking on the protocol logos.
 - Typing the order code in the **Order Code** field.



NOTE

The order code is printed on the silver label placed on the gateway's right side.

- Looking for it on the list.

Figure 3. Three possibilities for the template selection

New Project

Select BMS Protocol

Select Template

Order Code:

Project Name	BMS Protocol	Device Protocol	Description	Gateway Order Code
IN-KNX-BAC	KNX	BACnet Client	Intesis BACnet Client to KNX Gateway	IN778AIRxxxx0000 INKNDBACxxxxv000 IBKNDBACxxxxv000
IN-KNX-DALI-64	KNX	DALI	Intesis DALI to KNX Gateway	INKNXDAL064v000 IBKNXDAL064v000
IN-KNX-FJ	KNX	Fujitsu VRF	Intesis Fujitsu AC to KNX Gateway	INKNXFGLxxx0v000 IBKNXFGLxxx0v000
IN-KNX-HI	KNX	Hitachi	Intesis Hitachi AC to KNX Gateway	IN778AIRxxxx0000 INKNXHITxxx0v000 IBKNXHITxxx0v000
IN-KNX-HS	KNX	Hisense	Intesis Hisense AC to KNX Gateway	IN778AIRxxxx0000 INKNXHSxxx0v000 IBKNXHSxxx0v000
IN-KNX-LG	KNX	LG	Intesis LG AC to KNX Gateway	INKNXLGxxx0v000
IN-KNX-MBM	KNX	Modbus Master	Intesis Modbus Master to KNX Gateway	IN701KNXxxxx0000 INKNXMBMxxxv000 IBKNXMBMxxxv000
IN-KNX-MBUS	KNX	M-Bus	Intesis M-Bus to KNX Gateway	INKNXMBMxxxv000 IBKNXMBMxxxv000
IN-KNX-MD	KNX	Midea	Intesis Midea to KNX Gateway	IN778AIRxxxx0000
IN-KNX-ME	KNX	Mitsubishi Electric	Intesis Mitsubishi Electric AC to KNX Gate...	IN778AIRxxxx0000 INKNXMEITxxx0v000 IBKNXMEITxxx0v000
IN-KNX-MH	KNX	Mitsubishi Heavy Industries	Intesis Mitsubishi Heavy Industries to KNX...	IN776MHxxxx0000
IN-KNX-PA	KNX	Panasonic	Intesis Panasonic to KNX Gateway	IN778AIRxxxx0000 INKNXPAxxxx0v000 IBKNXPAxxxx0v000
IN-KNX-SM	KNX	Samsung NASA	Intesis Samsung NASA AC to KNX Gateway	IN778AIRxxxx0000 INKNXSASxxx0v000 IBKNXSASxxx0v000

Device model

Available Licenses

- 100 points
- 250 points
- 600 points
- 1200 points
- 3000 points

Order Codes

- IN701KNX1000000
- IN701KNX2500000
- IN701KNX6000000
- IN701KNX1200000
- IN701KNX3000000

3. Select the desired template.
4. Click **Next** or **double-click the template** on the list.



NOTE

Templates are just a starting point for your integration. Depending on the type of integration, you may have to modify some parameters.



IMPORTANT

Don't forget to save your project on your computer before exiting Intesis MAPS. To do so, go to **Project** → **Save** or **Save As**. Later on, you can load the project to Intesis MAPS and continue with the configuration.

8.2.3. Main Menu Overview

Figure 4. Intesis MAPS main menu



The following sections provide an overview of the five tabs that compose the Intesis MAPS main menu. Through these options, you will configure your project, send it to the gateway, and monitor that everything works fine using the **Diagnostic** tab.

8.2.4. Connection Tab

Click the **Connection** button in the menu bar to configure the gateway connection parameters.

Figure 5. Connection tab window

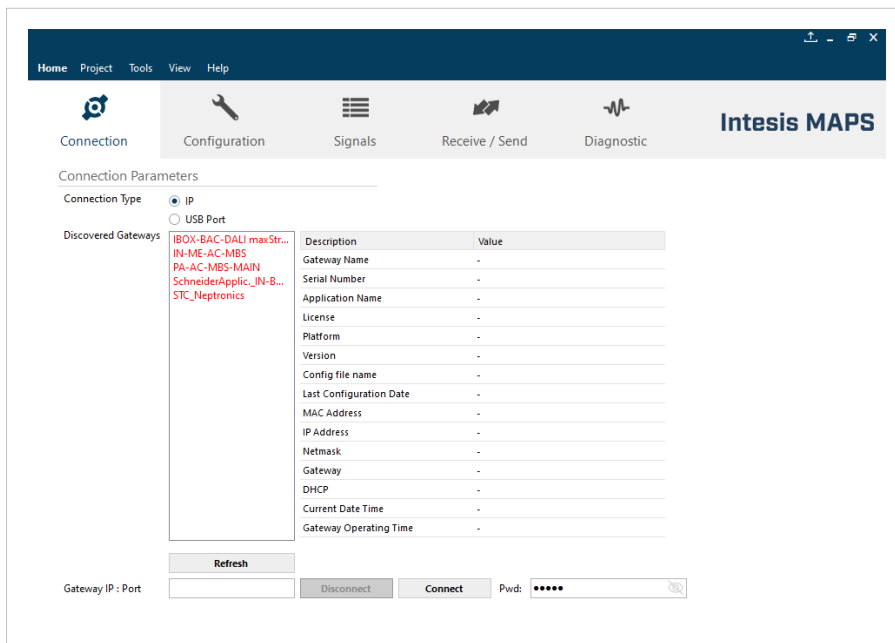

8.2.5. Configuration Tab

Select the **Configuration** tab to configure the connection parameters. This window contains three subsets of information: General (gateway general parameters), Modbus server (Modbus interface configuration), and M-Bus (M-Bus interface parameters).

Figure 6. Configuration tab window

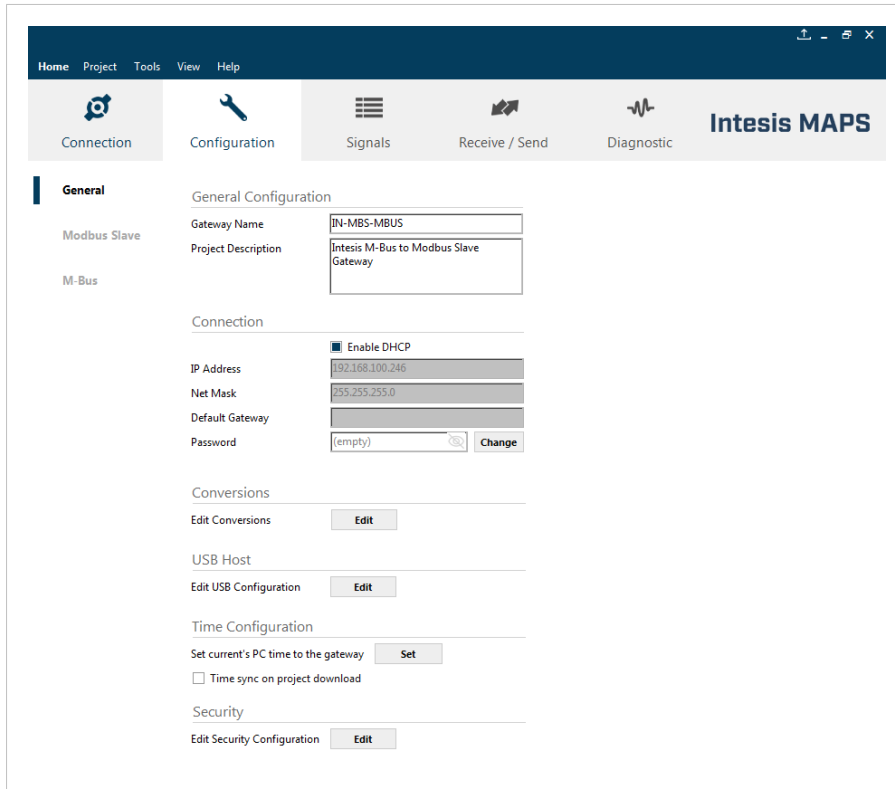

8.2.6. Signals Tab

All available objects, object instances, their corresponding Modbus register, and other main parameters are listed in the **Signals** tab. More information on each parameter and how to configure it can be found in the Intesis MAPS user manual.

Figure 7. Signals tab for the Modbus - integration

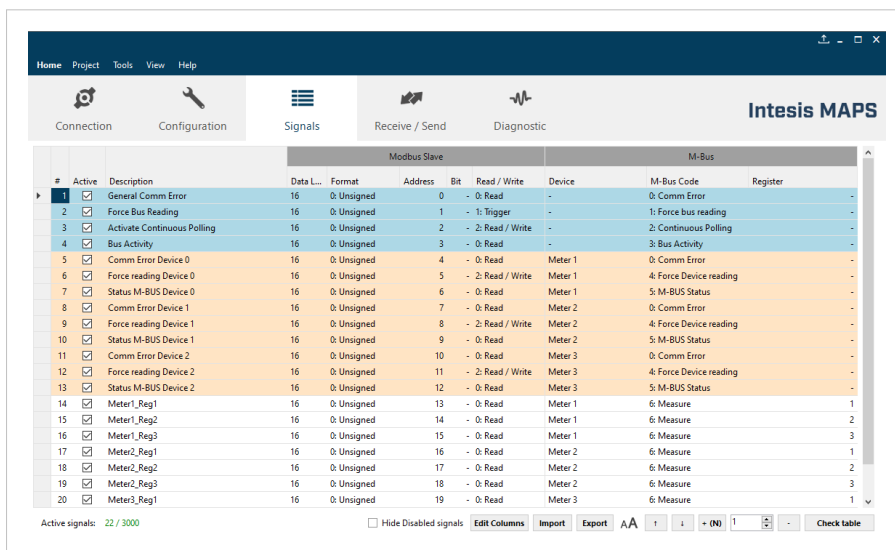

8.2.7. Receive/Send Tab

Send:

Once you have finished setting the parameters, you have to send the configuration to the gateway:

Follow these steps:

1. Click the **Send** button.
 - a. If the gateway is still factory-set, you will be prompted to save the project on your PC. Once saved, the configuration is automatically sent to the gateway.
 - b. If you have already saved the project, the configuration is automatically sent to the gateway.
2. Connect again with the gateway after sending the file.

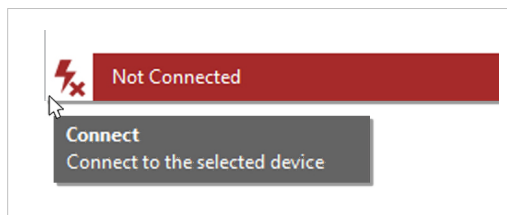

NOTICE

The gateway will reboot automatically once the new configuration is loaded. This process may take a few seconds.

Receive:

Use this function to get the configuration of a gateway, for example, when you need to change some parameters of a gateway already mounted in an installation.

Once the configuration is completed and sent, the gateway is already operative. Even so, you should check that everything is working correctly by entering the Diagnostic tab.

8.2.8. Diagnostic Tab

IMPORTANT
 Connection with the gateway is required to use the diagnostic tools.

Figure 8. Diagnostic tab window. Find the ToolBox between the upper tabs bar and the Console view. Below it, from left to right: Console viewer, Protocol viewers (one above the other), and the Signals viewer

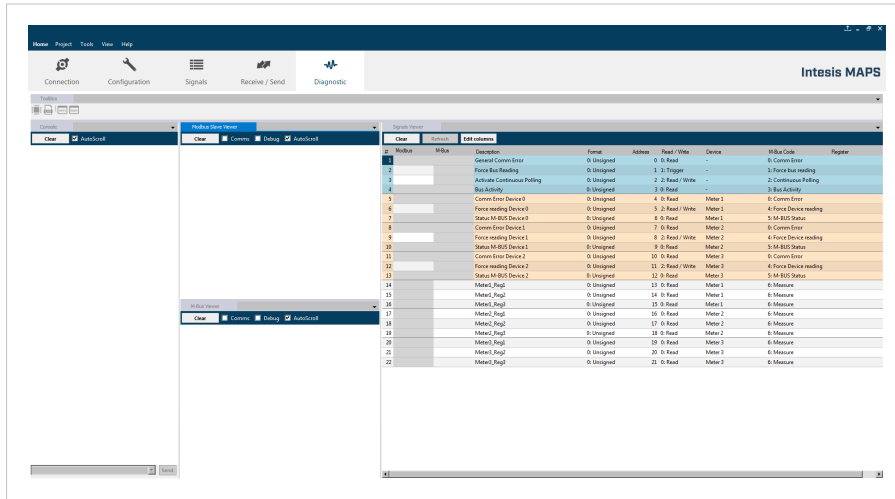

This section has two main parts:

ToolBox

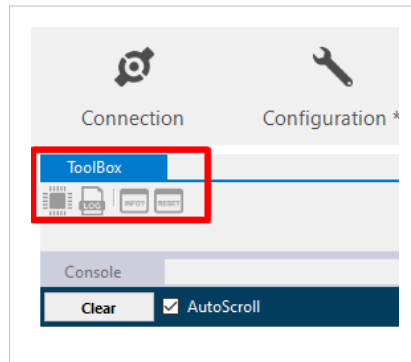

Use the tools section to:

- Check the current hardware status of the gateway.
- Save communication logs to a ZIP file for diagnostic purposes.
- Get information on the gateway.
- Reset the gateway.

Viewers

Intesis MAPS provides several viewers:

- A generic console viewer for general information about communications and the gateway status.
- A viewer for both protocols to check their current status.
- A signals viewer to simulate the BMS behavior or check the system's current values.

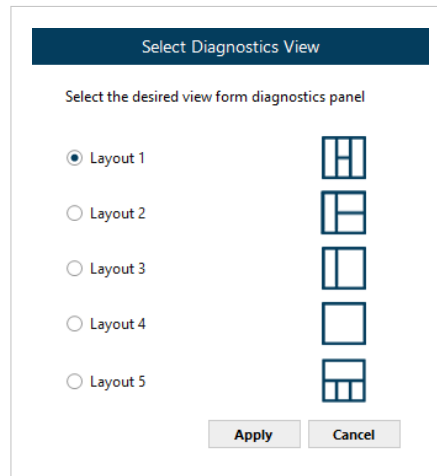

The layout of these viewers can be modified:

- Using the **Select Diagnostics View** option from the **View** menu:



NOTE

Layouts 3 and 4 offer two different tabbed options:

- Fixed console to the left and tabbed browser for the other viewers
 - Full tabbed browser
- Clicking and dragging the border of a viewer. To do so, place the cursor over the edge of a viewer. On the vertical edges, the cursor changes to  to adjust the width, and on the horizontal edges, the cursor changes to  to adjust the height.