

AC Cloud Control

Installation Sheet INWFITOS001R0XX



HMS Industrial Networks S.L.U

© 2019 HMS Industrial Networks S.L.U All rights reserved.

This document has been carefully written by HMS Industrial Networks S.L.U and a lot of effort has been made to ensure no errors or mistakes are present in the document. HMS Industrial Networks S.L.U is not responsible for printing or clerical errors.

Information in this document is subject to change without notice. No part of this publication may be reproduced, stored in a retrieval system or transmitted in any form or any means electronic or mechanical, including photocopying and recording for any purpose other than the purchaser's personal use without the written permission of HMS Industrial Networks S.L.U.

HMS Industrial Networks S.L.U
Milà i Fontanals, 7
08700 Igualada
Spain

Intesis[®] is a trademark of HMS Industrial Networks S.L.U Third party product names, company names and logos used in this document may be trademarks of their respective companies. Their use in this document is purely for information purposes only.

INDEX

1. Safety instructions3
2. AC Cloud Control parts.....3
3. Connection parts3
4. Connection process3
5. External Power Supply4
6. DIP-switches settings4

1. Safety instructions

⚠ WARNING

Carefully follow these safety and installation instructions. Improper work may lead to serious harm to your health and may seriously damage the Intesis AC Cloud Control device (hereafter referred to as “AC Cloud Control”) and/or the Indoor Unit.

- This AC Cloud Control must be installed by accredited technical personnel (electrician, installer, or authorized technical) following all the safety instructions.
- This AC Cloud Control must only be installed in a restricted access location.
- Before manipulating the Indoor Unit be sure it is completely disconnected from the main power.
- In case of installing the AC Cloud Control inside of the Indoor Unit, preferably fix the AC Cloud Control and its communication cables to an appropriate point of the Indoor Unit plastic cover, taking care to do not block the movement of mobile parts and as far as possible from tubes containing liquids and power cables.

2. AC Cloud Control parts

- A. Lid.
- B. LED indicator.
- C. Push button.
- D. AC connector.
- E. External Power Supply (PS) Connector.
- F. DIP-Switches.

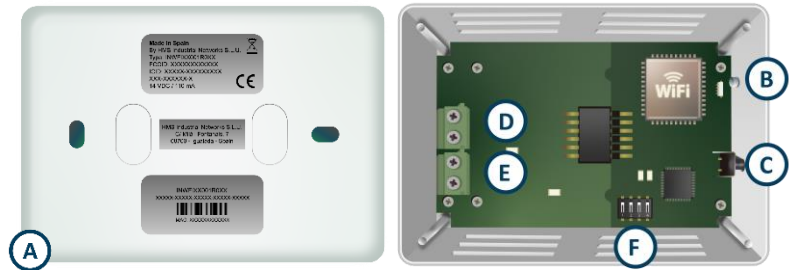

3. Connection parts

- A. AC Cloud Control.
- B. Wi-Fi Access point or router.
- C. AB connector.
- D. Remote Controller (RC).

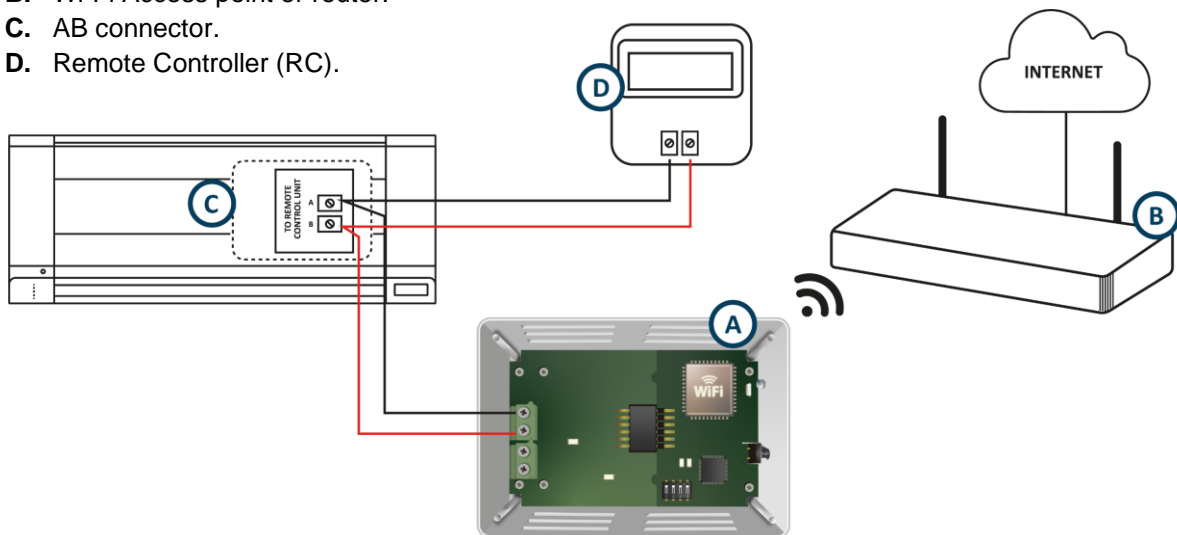

4. Connection process

1. Unplug the Indoor Unit from the main power.
2. Access to the main Printed Circuit Board.
3. Locate the AB socket connector.
4. Select a location for the AC Cloud Control.
5. Connect the AC Cloud Control to the Indoor Unit.
6. Close the Indoor Unit.
7. Plug the Indoor Unit to the main power.

5. External Power Supply

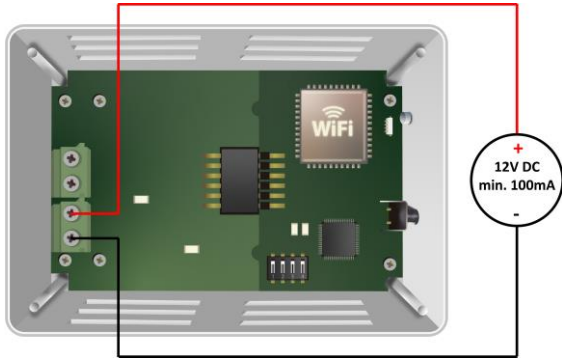

Important: If a wired remote controller of the Indoor Unit manufacturer is connected to the same bus, communication may shut down. Connect the PS connector of AC Cloud Control to an external power supply to overcome this situation.

Connect a NEC Class 2 or Limited Power Source (LPS) and SELV rated power supply to the AC Cloud Control, respecting the polarity. Always apply a voltage within the range admitted and of enough power (12V DC, min. 100 mA).

6. DIP-switches settings

Make sure the switches are properly set to cover your needs.

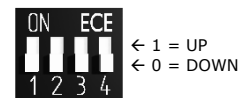

Switches 1 2 3 4	Description
1 X X X	Header in AB bus. Wired Remote Controller not needed. If it exists, it must be configured as Follower
0 X X X	Follower in AB bus. Wired Remote Controller must be present and configured as Header (Default value)
X 1 X X	Temperature in Fahrenheit
X 0 X X	Temperature in Celsius (Default value)
X X 1 X	High-Performance Mode
X X 0 X	Low-Performance Mode (Default value)
X X X 1	Maximum Wi-Fi range
X X X 0	Minimum Wi-Fi range (Default value)

Switch 3

This switch determines the performance of the AC Cloud Control. Running in High-Performance mode means maximum consumption and maximum performance.

Switch 4

This switch determines the Wi-Fi range of the AC Cloud Control. Consider that changing this switch may affect the AC Cloud Control Wi-Fi communication, making impossible for the AC Cloud Control in a running installation to reach the current access point or Wi-Fi network to which is connected.

In case no external supply is used: In very specific installations, the Indoor Unit port consumption may be overpassed, making the AC Cloud Control reboot. If that happens, decrease the AC Cloud Control consumption using SW3 and SW4.

NOTE: To save the switch setup, disconnect the indoor unit from the main power or the AC Cloud Control from the Indoor Unit.